



8020 9524



Biodrowy/piersiowy pas, stabilizujący

Hip-/Chest belt, upholstered

Becken-/Brustgurt, gepolstert

Heup-/Borstband met polstering

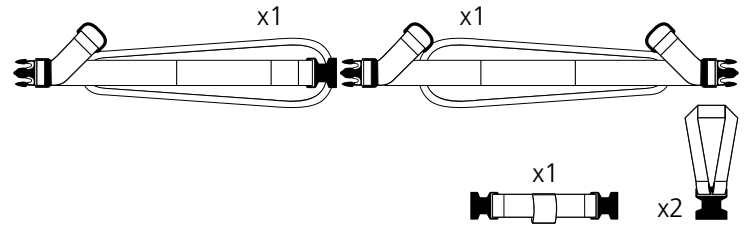

1a16263.5 2023-02-03

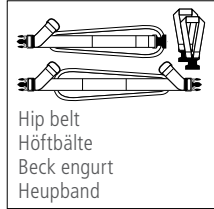

Swift Mobil (1-3A)

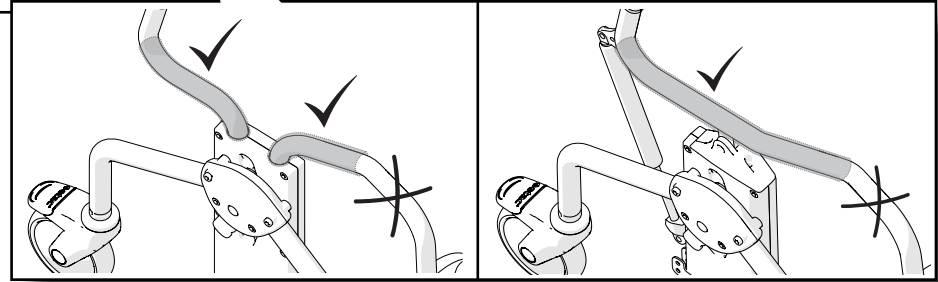
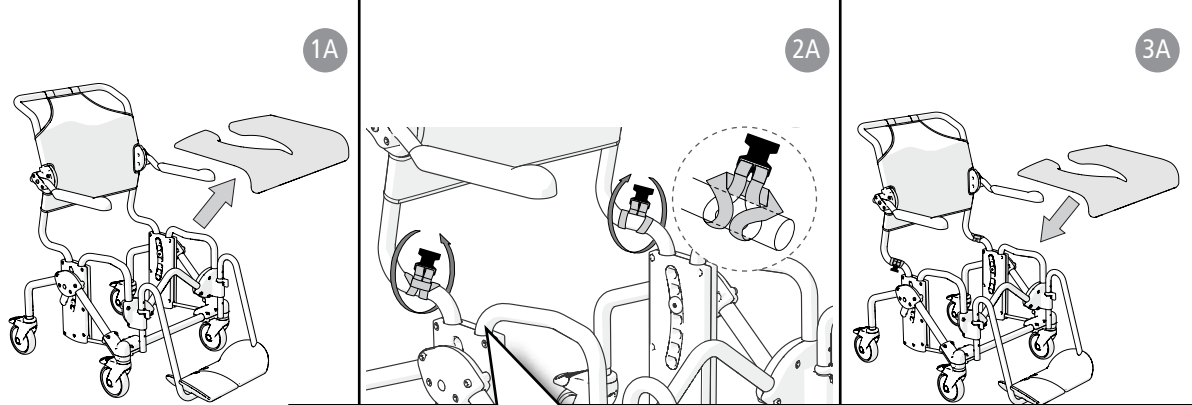
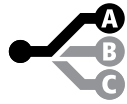

Clean (1B-C)

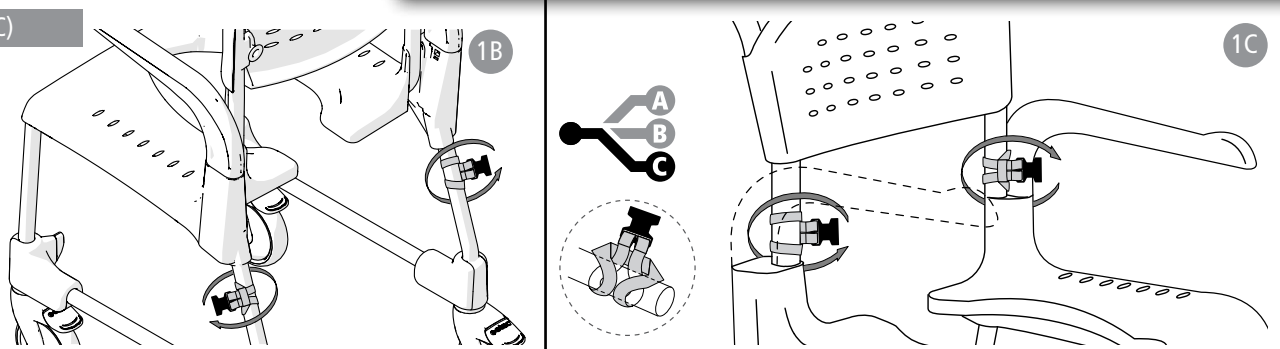
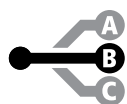

Swift Mobil,  
Clean (4-6)

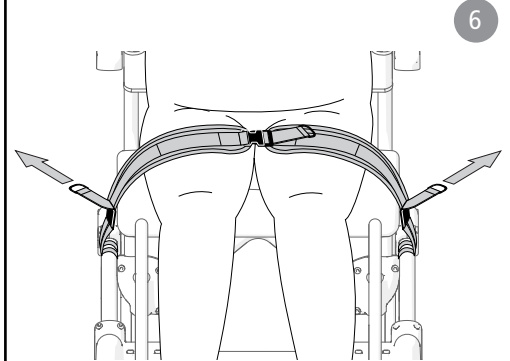
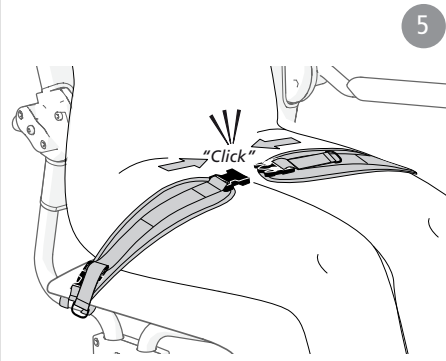
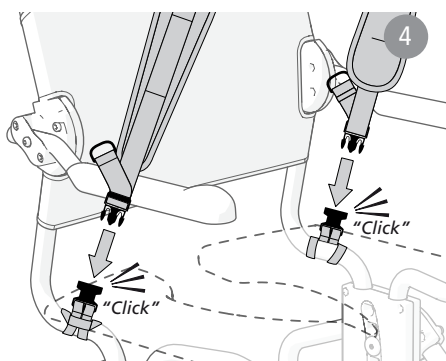

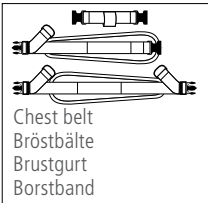

Swift Mobil

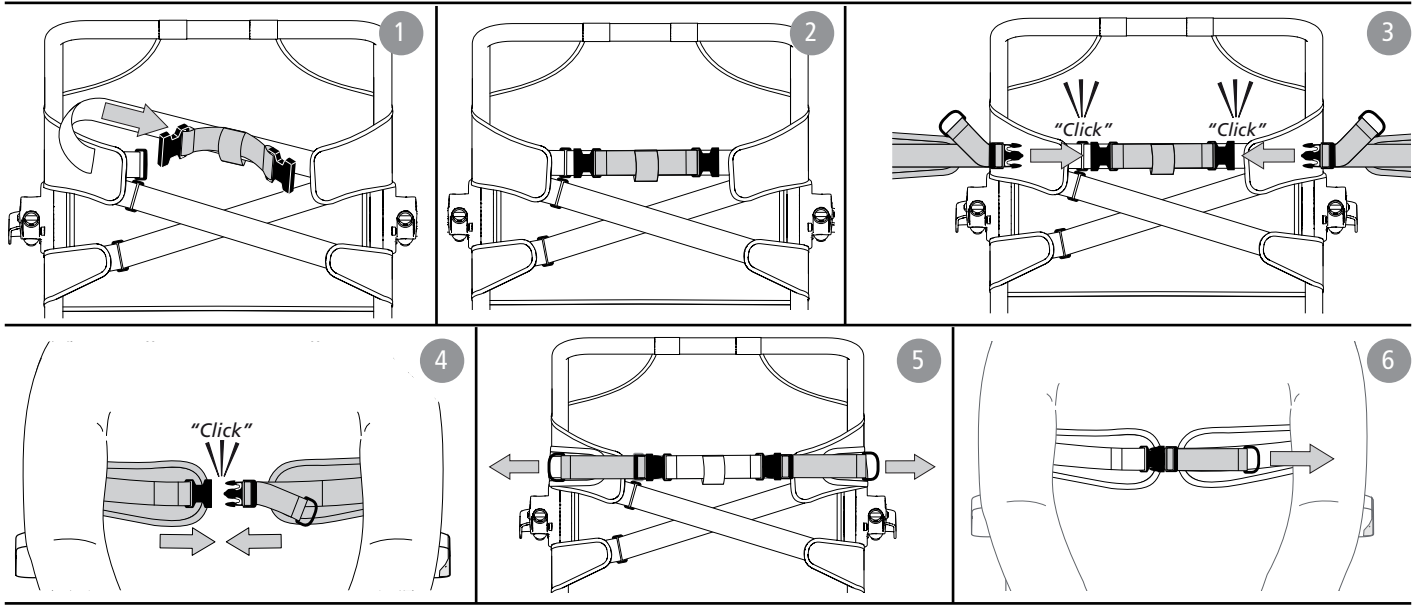

Clean

